

PORTABLE COMPACT DISC PLAYER

DPC-141

INSTRUCTION MANUAL

KENWOOD CORPORATION

KENWOOD

Note for use in automobiles

If you use the unit in your car, install it in a place not subject to direct sunlight. Also do not leave that unit in car when not in use, for this will cause damage to the unit such as deformation by direct sunlight.

COMPACT
disc
DIGITAL AUDIO

Introduction

Your choice of this product indicates that you are a devotee to excellence in sound reproduction. We appreciate your patronage and take pride in the long tradition of quality components that our company represents. So that you can get the most out of your unit, we suggest that you take the time to read through this manual before you hook up and operate your system. This will acquaint you with operating features and system-connection considerations so that your listening pleasure will be enhanced right from the start. You will notice that in all aspects of planning, engineering, styling, operating convenience and adaptability we have sought to anticipate your needs and desires.

Keep this manual handy for future reference.

For your records

Record the serial number, found on the bottom of the unit, in the spaces designated on the warranty card, and in the space provided below. Refer to the model and serial numbers whenever you call upon your dealer for information or service on this product.

Model _____ Serial Number _____

Unpacking

Unpack the unit carefully and make sure that all accessories are put aside so they will not be lost. Examine the unit for any possibility of shipping damage. If your unit is damaged or fails to operate, notify your dealer immediately. If your unit was shipped to you directly, notify the shipping company without delay. Only the consignee (the person or company receiving the unit) can file a claim against the carrier for shipping damage. We recommend that you retain the original carton and packing materials for use should you transport or ship the unit in the future.

Accessories

- AC adaptor

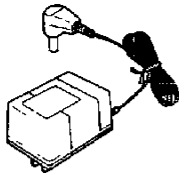

- Open airtype headphone
(For U.S.A., Canada and Europe)





- Micro headphone
(Except for U.S.A., Canada and Europe)



Contents

Caution: Read the pages marked  carefully to ensure safe operation.

Introduction	2	Starting playback from the desired track	12
 Before applying power	3	Programmed playback	13
 Safety precautions	3	Special playback operations	15
 IMPORTANT SAFEGUARDS	4	Varying the tone	16
Power supplies	7	Listening through speaker system	16
Controls and indicators	9	In case of difficulty	17
Preparation for playback	10	Specifications	18
Basic operation	11		

Before applying power

⚠ Caution: Read this page carefully to ensure safe operation.

For the U.S.A. and Canada

Important!

Units shipped to the U.S.A. and Canada are designed for operation on 120 volts AC only.

CAUTION: TO PREVENT ELECTRIC SHOCK DO NOT USE THE AC PLUG WITH AN EXTENSION CORD, RECEPTACLE OR OTHER OUTLET UNLESS THE BLADES CAN BE FULLY INSERTED TO PREVENT BLADE EXPOSURE.

For the United Kingdom

Important!

Units shipped to the U.K. are designed for operation on 240 volts AC only.

Factory fitted moulded mains plug

1. The mains plug contains a fuse. For replacement, use only a 13-Amp ASTA-approved (BS1362) fuse.
2. The fuse cover must be refitted when replacing the fuse in the moulded plug.
3. Do not cut off the mains plug from this equipment. If the plug fitted is not suitable for the power points in your home or the cable is too short to reach a power point, then obtain an appropriate safety approved extension lead or adapter, or consult your dealer.
If nonetheless the mains plug is cut off, remove the fuse and dispose of the plug immediately, to avoid a possible shock hazard by inadvertent connection to the mains supply.

For Europe

Important!

Units shipped to Europe are designed for operation on 230 V AC only.

For other countries

Important!

AC adaptor shipped to countries other than the above are equipped with an AC voltage selector switch on the bottom cover. Refer to the following paragraph for the proper setting of this switch.

AC voltage selection

AC adaptor operates on 115 volts or 230 volts AC. Before connecting the power cord to your AC outlet, make sure that the setting position of this switch matches your line voltage. If not, it must be set to your voltage in accordance with the following direction.

Note:

Our warranty does not cover damage caused by excessive line voltage due to improper setting of the AC voltage selector switch.



The AC adaptor is provided with a voltage selector switch which has been preset for 230 V.

If using it with 110 - 120 V power, set the switch to the 115 V position.

AC voltage selector switch

Fig. 1

Safety precautions

WARNING: TO PREVENT FIRE OR ELECTRIC SHOCK, DO NOT EXPOSE THIS APPLIANCE TO RAIN OR MOISTURE.

The marking of products using lasers (Except for some areas).

This label is attached to the bottom panel and says that the component uses laser beams that have been classified as Class 1. It means that the unit is utilizing laser beams that are of a weaker class. There is no danger of hazardous radiation outside the unit.

WARNING NOTICE:

IN MOST CASES IT IS AN INFRINGEMENT OF COPYRIGHT TO MAKE COPIES OF TAPES OR DISCS WITHOUT THE PERMISSION OF THE COPYRIGHT OWNERS. ANYONE WISHING TO COPY COMMERCIALY AVAILABLE TAPES OR DISCS SHOULD CONTACT THE MECHANICAL COPYRIGHT PROTECTION SOCIETY LIMITED OR THE PERFORMING RIGHTS SOCIETY LIMITED.

IMPORTANT SAFEGUARDS

 **Caution: Read this page carefully to ensure safe operation.**

Please read all of the safety and operating instructions before operating this unit. For best results, follow all warnings placed on the unit and adhere to the operating and use instructions. These safety and operating instructions should be retained for future reference.

- 1. Power sources** — The unit should be connected to a power supply only of the type described in the operating instructions or as marked on the appliance.
- 2. Power-cord protection** — Power-supply cords should be routed so that they are not likely to be walked on or pinched by items placed upon or against them, pay particular attention to cords at plugs, convenience receptacles, and the point where they exit from the unit.
- 3. Enclosure removal** — Never remove the enclosure. If the internal parts are touched accidentally, a serious electric shock might occur.
- 4. Drop** — Do not drop the unit or apply strong shock to it. (Damage due to dropping the unit is not covered by the warranty.)
- 5. Ventilation** — Avoid hindering the ventilation of the unit by covering it with a cloth, etc.
- 6. Abnormal smell** — If an abnormal smell or smoke is detected, immediately turn the power OFF and pull out the power cord. Contact your dealer or nearest service center.
- 7. Heat** — Avoid placing the unit under direct sunlight or near a source of heat such as heating equipment. Particularly, never leave it in an automobile or on the dashboard.
- 8. Temperature** — The unit may not function properly if used at extremely low, or freezing temperatures. The ideal ambient temperature is above +5°C (41°F).
- 9. Water and moisture** — The unit should not be used near water — for example, near a bathtub, washbowl, kitchen sink, laundry tub, in a wet basement, or near a swimming pool, etc.
- 10. Dust and moisture** — Avoid places where is dusty or where the humidity is high.
- 11. Vibrations** — Avoid placing the unit on an unstable place such as a shelf or in a place subject to vibrations.
- 12. Magnetic fields** — Keep the unit away from sources of magnetic fields such as TV sets, speaker systems, radios, motorized toys or magnetized objects.
- 13. Cleaning** — Do not use volatile solvents such as alcohol, paint thinner, gasoline, or benzene, etc. to clean the cabinet. Use a clean dry cloth.
- 14. Nonuse periods** — The power cord of the unit should be unplugged from the outlet when left unused for a long period of time.
- 15. Damage requiring service** — The unit should be serviced by qualified service personnel when:
 - A.** The power-supply cord or the plug has been damaged; or
 - B.** Objects have fallen, or liquid has been spilled into the unit; or
 - C.** The unit has been exposed to rain; or
 - D.** The unit does not appear to operate normally or exhibits a marked change in performance; or
 - E.** The unit has been dropped, or the enclosure damaged.
- 16. Servicing** — The user should not attempt to service the unit beyond that described in the operating instructions. All other servicing should be referred to qualified service personnel.

In case of abnormality, immediately press the open key to turn the power OFF, and unplug the AC adapter from the power outlet. Then please contact your nearest KENWOOD service center.



Dear Customer:

Selecting fine audio equipment such as the unit you've just purchased is only the start of your musical enjoyment. Now it's time to consider how you can maximize the fun and excitement your equipment offers. This manufacturer and the Electronic Industries Association's Consumer Electronics Group want you to get the most out of your equipment by playing it at a safe level. One that lets the sound come through loud and clear without annoying blaring or distortion — and, most importantly, without affecting your sensitive hearing.

Sound can be deceiving. Over time your hearing "comfort level" adapts to higher volumes of sound. So what sounds "normal" can actually be loud and harmful to your hearing. Guard against this by setting your equipment at a safe level BEFORE your hearing adapts.

To establish a safe level:

- Start your volume control at a low setting.
- Slowly increase the sound until you can hear it comfortably and clearly, and without distortion.

Once you have established a comfortable sound level:

- Set the dial and leave it there.

Taking a minute to do this now will help to prevent hearing damage or loss in the future. After all, we want you listening for a lifetime.

We Want You Listening For A Lifetime

Used wisely, your new sound equipment will provide a lifetime of fun and enjoyment. Since hearing damage from loud noise is often undetectable until it is too late, this manufacturer and the Electronic Industries Association's Consumer Electronics Group recommend you avoid prolonged exposure to excessive noise. This list of sound levels is included for your protection.

<u>Decible Level</u>	<u>Example</u>
30	Quiet library, soft whispers
40	Living room, refrigerator, bedroom away from traffic
50	Light traffic, normal conversation, quiet office
60	Air conditioner at 20 feet, sewing machine
70	Vacuum cleaner, hair dryer, noisy restaurant
80	Average city traffic, garbage disposals, alarm clock at two feet.

THE FOLLOWING NOISES CAN BE DANGEROUS UNDER CONSTANT EXPOSURE

90	Subway, motorcycle, truck traffic, lawn mower
100	Garbage truck, chain saw, pneumatic drill
120	Rock band concert in front of speakers, thunderclap
140	Gunshot blast, jet plane
180	Rocket launching pad

Information courtesy of the Deafness Research Foundation.

Disc handling precautions

Handling

Hold compact discs so that you do not touch the playing surface.

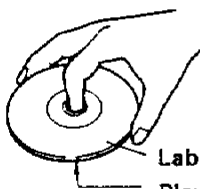

Label side
Playing side

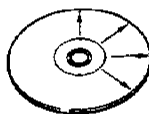

Cleaning

If fingerprints or foreign matter become attached to the disc, lightly wipe the disc with a soft cotton cloth (or similar) from the center of the disc outwards in a radial manner.



Do not attach paper or tape to either the playing side or the label side of compact discs.

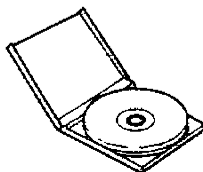

Storage

When a disc is not to be played for a long period of time, remove it from the CD player and store it in its case.

Caution on disc used



Never play a cracked or warped disc.

During playback, the disc rotates at high speed in the player. Therefore, to avoid danger, never use a cracked or deformed disc or a disc repaired with tape or adhesive agent.

8 cm single CD

- This unit can play 8 cm single CD directly, without the help of an adapter. (Do not use single CD adapter sold in audio or record stores, for this may lead to malfunction.)

Condensation

- Immediately after a heater is turned on or when the unit is used in a room with high steam content or moisture, dew may be condensed on the lens inside the unit, causing malfunction. In this case, set the POWER switch of the unit to OFF, leave the unit for about an hour, then place a disc and start playback.

■ Simple maintenance

Lens maintenance

Stain on the laser pickup lens may cause sound skip or other troubles making CD playback impossible. Clean the lens using a commercially-available camera blower, etc. Do not use commercially-available lens cleaner or disc cleaner.

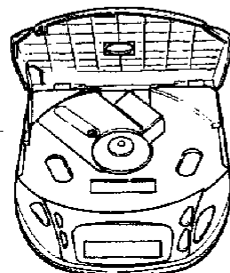

Cabinet maintenance

If the cabinet becomes dirty, wipe with a soft, dry cloth. Serious stain or dirt can be wiped with a wet cloth. Do not use benzine or thinner for these may damage the unit.

Power supplies

This unit can be powered from batteries or household power supply. For battery operation, use commercially-available alkaline batteries or the rechargeable batteries.

Manganese batteries are not suitable for operating this unit, because their capacity is too small to be used.

After switching the power OFF, the batteries are slightly consumed to hold the memory functions.

When the unit is not used for a long time (a week or more), remove the batteries from the unit.

■ Operation on household power supply

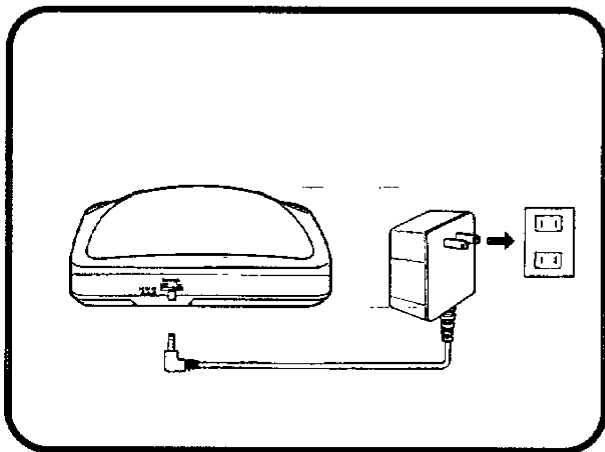

Caution in use of AC adapter:

1. Never use other AC adapter than that supplied with this unit.
2. When the unit is not to be used, unplug the AC adapter from the power outlet.

ATTENTION

Nickel-Cadmium battery must be recycled or disposed of properly.

State laws may vary regarding the handling and disposal of Nickel-Cadmium batteries.

Please contact your Authorized KENWOOD Dealer for more information.

■ Operation on alkaline batteries

When the unit is to be powered from batteries, use "LR6" alkaline batteries. They make about 5 hours of playback possible under normal temperatures.

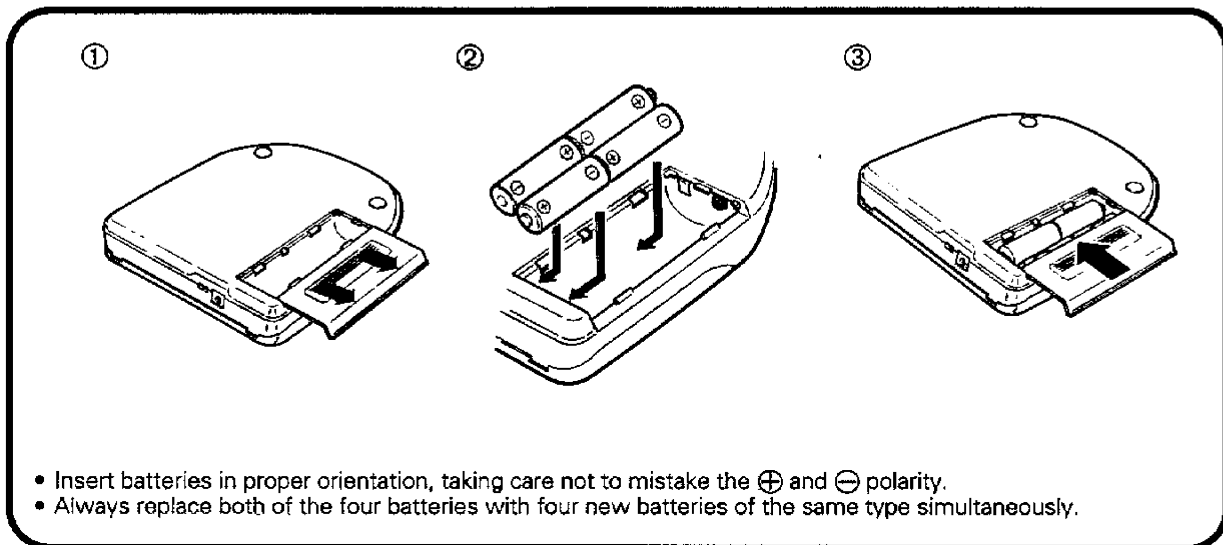

■ Operation on rechargeable batteries

Be sure to recharge the batteries when they are used for the first time, when they have not been used for a long period or when the battery indicator is blinking. It takes about eight hours until the fully charged condition, and about 2 hours of playback is possible from this condition under normal temperatures.

1 Insert rechargeable batteries taking care of the correct polarity.

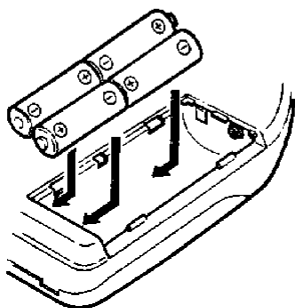

- Insert them taking care not to mistake the orientations of the ⊕ and ⊖ poles.
- Batteries cannot be recharged during playback.
- A rechargeable battery can be recharged about 500 times. When the operable period shortens, please purchase new optional rechargeable batteries (NB-77).

2 Start recharging.

- ① Check that the power is in the OFF condition.
- ② Connect the AC adaptor.

When the indicator blinks, recharge the battery.

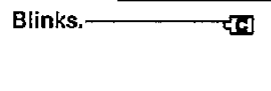
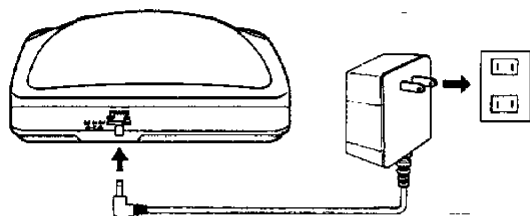

- Recharging completes in about 8 hours.

After charging, disconnect the AC adaptor from the wall outlet and the unit.

- Be sure to shut the cover of the unit during recharging.
- Avoid recharging the battery for more than 8 hours.

This unit is not accompanied with a rechargeable battery. This unit can be used to recharge the optional NB-77 or NB-88 rechargeable battery which is available separately. Rechargeable batteries of other brands or models cannot be recharged with this unit.

Note:

As an inherent characteristic of rechargeable batteries, the charging capacity drops if a battery is recharged several times while the charge remaining in it is large. In such a case, the original charging capacity can be recovered gradually by recharging it only after the charge has been exhausted completely several times.

Controls and indicators

■ Main unit

Front panel

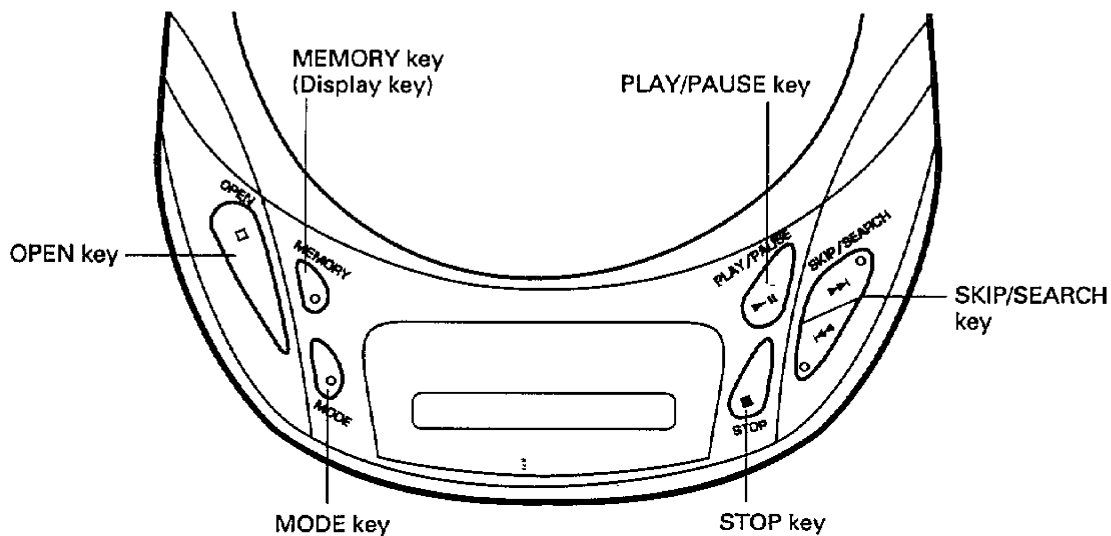

Side panels

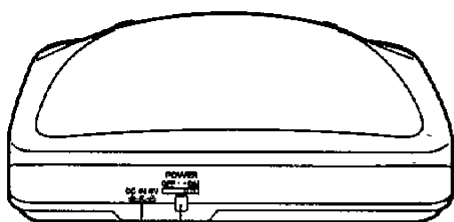

DC IN jack
(External DC power input)

POWER switch

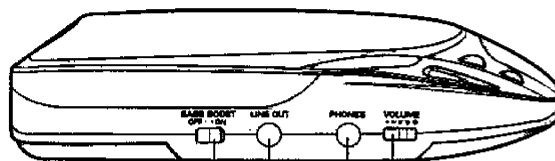

BASS BOOST switch

LINE OUT jack

PHONES jack
(Headphones)

Volume control switch

Main panel display

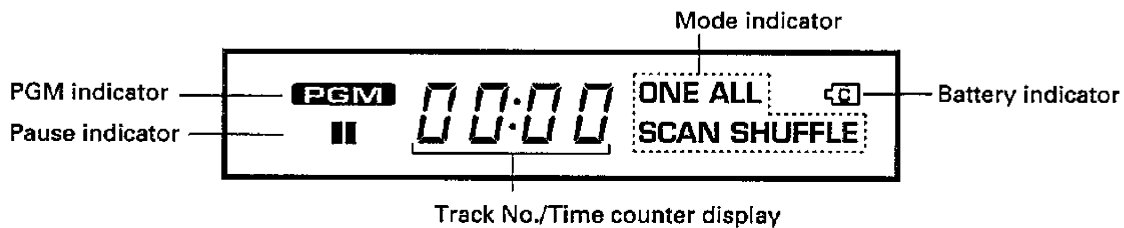

Preparation for playback

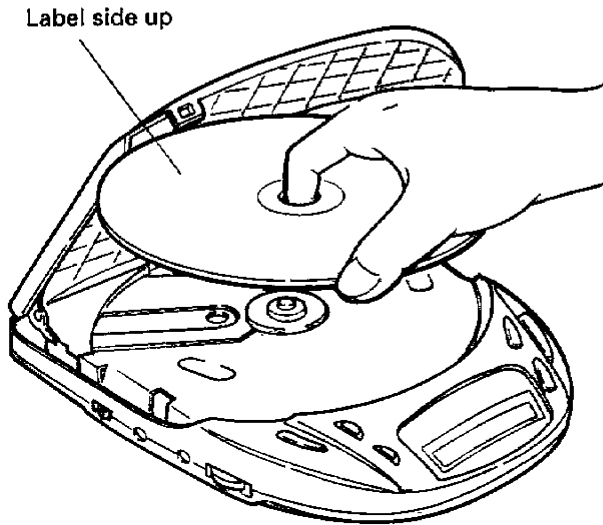

■ Connecting headphones

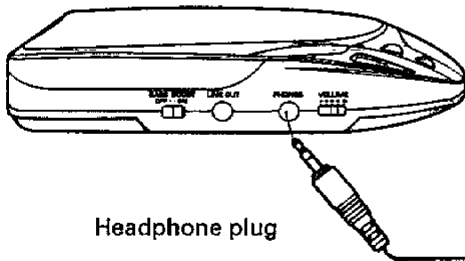

- Use headphones equipped with a stereo mini-plug.

■ Turning power ON

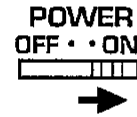

- Set the POWER switch on the rear panel to ON.

■ To insert a disc

1 Open the cover.



2 Insert a disc.

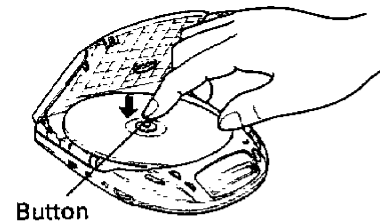

- Fit the center pivot into the disc hole and press the button.

3 Close the cover.

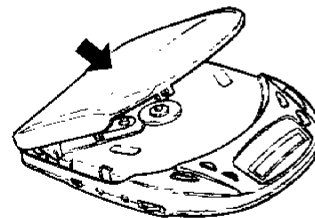

- Press down the left front side of the cover until it locks in place with a click.

Basic operation

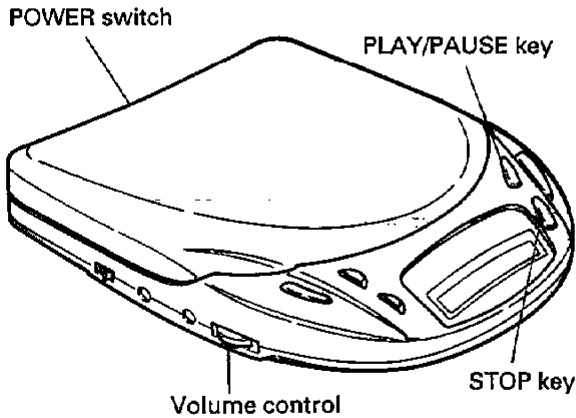

■ Normal playback

1 Start playback.



Track No.

- Each time the MEMORY key is pressed, the track No. and time of the selection being played are displayed alternately.

Pausing playback

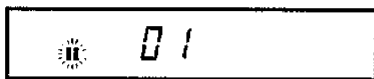

Blinks.

- Press again to resume playback.

2 Adjust the volume.

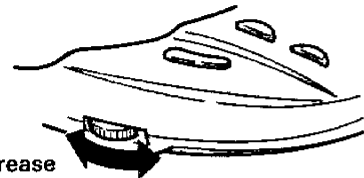

To decrease

To increase

To stop playback

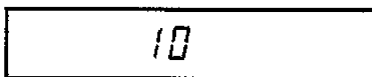

- Total track No. and total playing time are displayed alternately.

To turn the power OFF



- After playback, be sure to set the POWER switch to OFF. Otherwise, the battery may be exhausted because a small amount of current flows while the power is ON, even when the player is in stop mode.

Starting playback from the desired track

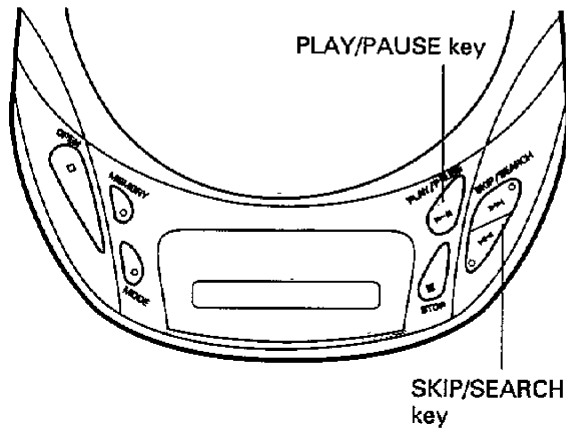

■ Track search

Specifying the skip destination track.

Tap lightly the **SKIP/SEARCH** key corresponding to the direction you want to skip during playback.

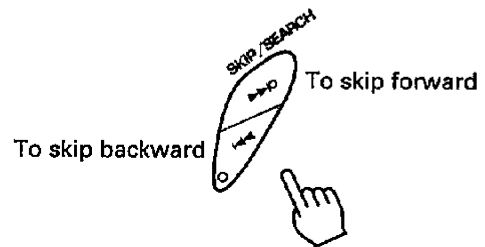

- The same number of tracks as the number of times the key is tapped are skipped.
- When the  key is tapped once during playback, the track being played will be replayed from the beginning.
- To skip the track in the stop mode, press the SKIP/SEARCH key, then press the PLAY/PAUSE key.

Fast forward or fast backward search

Press and hold the search key corresponding to the direction you want to search during playback.

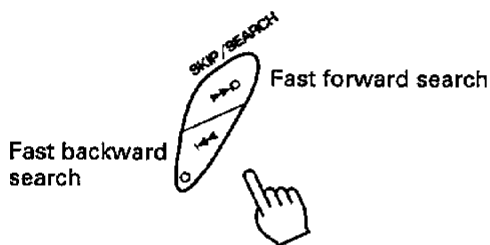

- Normal playback resumes from the position you release the key.

Programmed playback

Before programming, be sure to set the CD player in the stop mode.

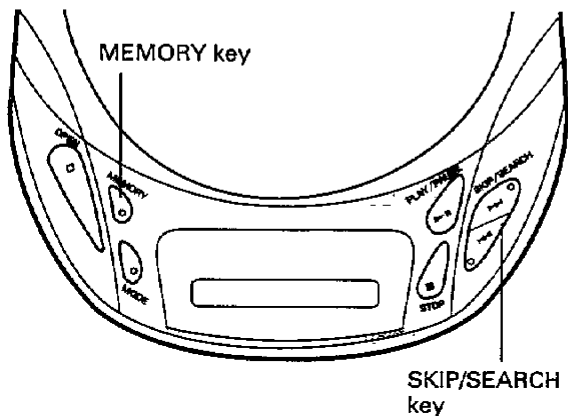

■ Programmed playback procedure

1 Enter the stop mode.

2 Initiate the program mode.

Press the MEMORY key.



Program No. Track No.

3 Program desired tracks in the desired order.

① Select a track.

To select track No. 3 as program No. 1:

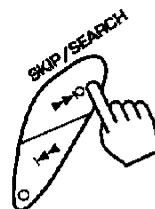

Press three times.

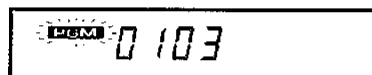

② Press the MEMORY key.

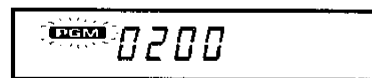

- Program other desired tracks by repeating steps ① and ② for each track.
- Up to 20 tracks can be programmed.

4 Start playback.

Press the PLAY/PAUSE key.

- The SKIP/SEARCH key does not function when the unit is stopped in the program mode.

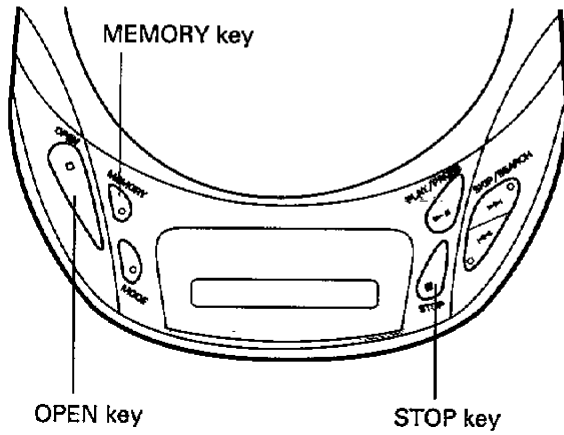

■ Checking the program contents

1 Enter the stop mode.

2 Press the MEMORY key.

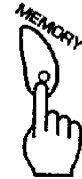

- Every time the key is pressed, the track numbers are displayed in the order they are programmed.

■ Canceling the program

Press the STOP key twice or OPEN key.

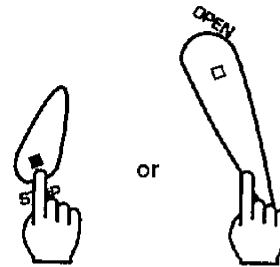

Special playback operations

Various playback operations are available by pressing the MODE key in the play mode or stop mode.

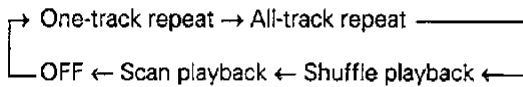

Each press switches over the play modes.



ONE	One-track repeat The track being played or a selected track will be played repeatedly.	
ALL	All-track repeat All tracks on the disc will be played repeatedly.	
SHUFFLE	Shuffle A track which has been played by shuffle playback will not be played twice in the same shuffle playback. <ul style="list-style-type: none"> • If the shuffle playback mode is initiated during normal playback, the shuffle playback starts after the track being played has completed. 	
SCAN	Scan playback A part of every track on the disc will be played for 10 seconds each. <ul style="list-style-type: none"> • If the scan playback mode is initiated during normal playback, scan playback starts from the beginning of the first track on the disc. 	
OFF	Cancellation Normal playback mode resumes.	

Varying the tone

This unit has the **Bass Boost** function which allows to enjoy more powerful sound by enhancing the low frequencies. Switch this function **ON** or **OFF** to select the tone you like.

■ BASS BOOST

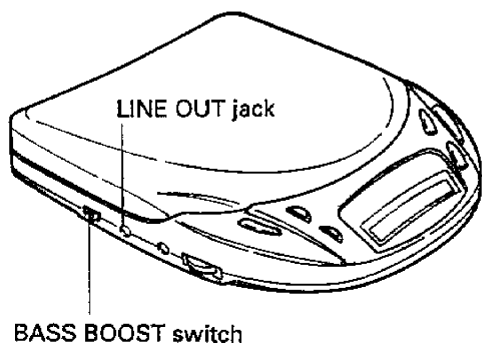

BASS BOOST

OFF • • ON

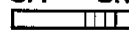

- Set the **BASS BOOST** switch to **ON** if you want to enhance the low frequencies.

Listening through speaker system (option)

The unit can be connected to the **KENWOOD's Active Speaker (AS-5, AS-7 etc.)**.

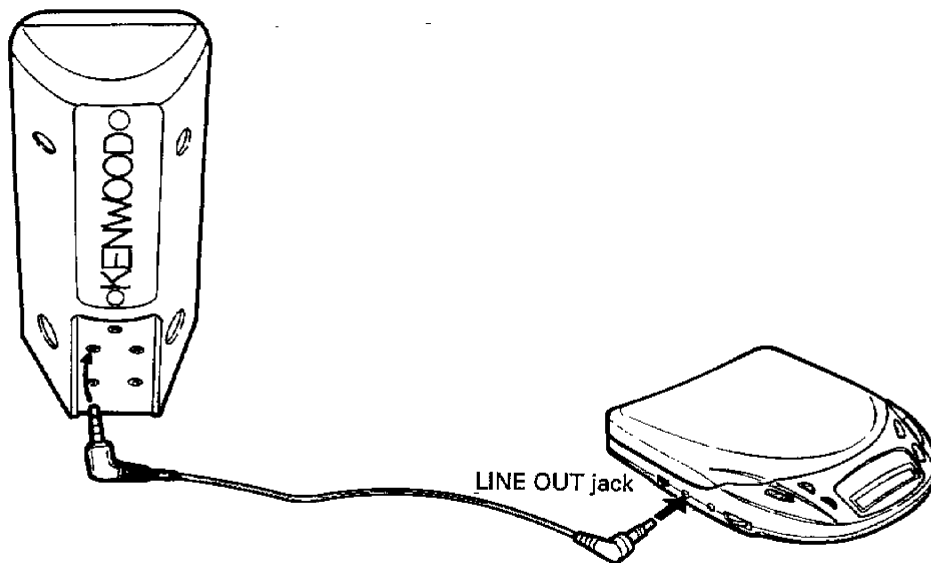

Notes:

1. Be sure to turn the power of the speakers **OFF** before connecting them to this unit.
2. The playback volume should be adjusted on the speakers.
3. The Bass Boost function of this unit is defeated while the speaker system is connected.

In case of difficulty

What seems to be a serious trouble is often due to simple mistake. In case of trouble, check it again by referring to the table below.

Note that servicing may be charged if it is requested based on the following symptoms.

Symptom	Cause	Remedy
Operation does not occur when an operation key is pressed.	<ul style="list-style-type: none">• The batteries are exhausted.• The disc is placed upside down.• Dew is condensed inside the unit.• The AC adapter is disconnected.	<ul style="list-style-type: none">• Replace both of the four alkaline batteries, or recharge the rechargeable batteries.• Place the disc with the label side facing upward.• Leave the unit for about an hour before use.• Connect it properly.
No sound is output through headphones.	<ul style="list-style-type: none">• The headphones plug is connected incompletely.• The volume control of the main unit or remote control unit is set in a low position.	<ul style="list-style-type: none">• Insert it securely into the PHONES jack.• Adjust the volume control of the main unit or remote control unit.
Sound skips or interrupts.	<ul style="list-style-type: none">• The unit is used in a place subject to large vibrations.• The disc is dirty.• The internal lens is dirty.• The headphones plug is dirty.• The batteries are exhausted.	<ul style="list-style-type: none">• Place the unit in a place subject to small vibrations.• Clean it.• Clean it.• Clean it.• Recharge or replace them.
Noise is heard.	<ul style="list-style-type: none">• The headphones plug is dirty.• The batteries are exhausted.• The headphones plug is connected incompletely.	<ul style="list-style-type: none">• Clean it.• Recharge or replace them.• Insert it securely into the PHONES jack.

Notes:

1. This system is microprocessor-controlled, so malfunction may occur due to external noise or interference noise. In such a case, unplug the power cord, plug it and turn power on again.
2. Do not use contact cleaners because it could cause a malfunction. Be specially careful against contact cleaners containing oil, for they may deform the plastic components.
3. If plugging or unplugging the headphones, the unit may not function correctly. However, it is not a malfunction.

Specifications

Format

System Compact disc digital audio system
Laser Semiconductor laser

Audio

Frequency response 20 Hz ~ 20 kHz, ± 3 dB
Output level/impedance
LINE OUT 0.8 V/2.2 k Ω
Headphone output 10 mW + 10 mW (32 Ω , 1 kHz)

General

Power supply
External power DC 6 V
Commercially-available alkaline batteries $\times 4$ DC 6 V
Battery life (continuous repeat playback)
Commercially-available alkaline batteries (4) Approx. 5 hours
Dimensions W: 134 mm
H: 29.9 mm
D: 158 mm
Weight (Net) 278 g

Note:

KENWOOD follows a policy of continuous advancements in development. For this reason specifications may be changed without notice.

For the U.S.A.

CAUTION:

Use of controls or adjustments or performance of procedures other than those specified herein may result in hazardous radiation exposure.

In compliance with Federal Regulations, following are reproductions of labels on, or inside the product relating to laser product safety.

KENWOOD CORPORATION
SHIONOGI SHIBUYA BUILDING 17-5,
2-CHOME, SHIBUYA, SHIBUYA-KU,
TOKYO, JAPAN

KENWOOD CORP. CERTIFIES THIS EQUIPMENT
CONFORMS TO DHHS REGULATIONS NO. 21
CFR 1040.10, CHAPTER I, SUBCHAPTER J.

Location: Bottom Panel

**For the U.S.A.
FCC WARNING:**

This equipment may generate or use radio frequency energy. Changes or modifications to this equipment may cause harmful interference unless the modifications are expressly approved in the instruction manual. The user could lose the authority to operate this equipment if an unauthorized change or modification is made.

NOTE:

This equipment has been tested and found to comply with the limits for a CLASS B digital device, pursuant to Part 15 of the FCC Rules. These limits are designed to provide reasonable protection against harmful interference in a residential installation. This equipment may cause harmful interference to radio communications, if it is not installed and used in accordance with the instructions. However, there is no guarantee that interference will not occur in a particular installation. If this equipment does cause harmful interference to radio or television reception, which can be determined by turning the equipment off and on, the user is encouraged to try to correct the interference by one or more of the following measures:

- Reorient or relocate the receiving antenna.
- Increase the separation between the equipment and receiver.
- Connect the equipment into an outlet on a circuit different from that to which the receiver is connected.
- Consult the dealer or an experienced radio/TV technician for help.

**For CANADA
DOCREGULATION**

"This digital apparatus does not exceed the CLASS B limits for radio noise emissions from digital apparatus as set out in the radio interference regulations of the Canadian Department of Communications."

KENWOOD